

SANYO	No.2265A	2SB1269/2SD1905
		PNP/NPN Epitaxial Planar Type Silicon Transistors HIGH-CURRENT SWITCHING APPLICATIONS

Applications

- . Suitable for relay drivers, high-speed inverters, converters, and other general high-current switching applications

Features

- . Suitable for sets whose height is restricted
- . Low collector to emitter saturation voltage
- . Wide ASO and highly resistant to breakdown

(): 2SB1269

Absolute Maximum Ratings at Ta=25°C

			unit
Collector to Base Voltage	V _{CB0}	(-)60	V
Collector to Emitter Voltage	V _{CEO}	(-)50	V
Emitter to Base Voltage	V _{EBO}	(-)6	V
Collector Current	I _C	(-)7	A
Peak Collector Current	i _{cp}	(-)12	A
Collector Dissipation	P _C	1.65	W
		40	W
	T _c =25°C		
Junction Temperature	T _j	150	°C
Storage Temperature	T _{stg}	-55 to +150	°C

Electrical Characteristics at Ta=25°C

		min	typ	max	unit
Collector Cutoff Current	I _{CB0} V _{CB} =(-)40V, I _E =0			(-)0.1	mA
Emitter Cutoff Current	I _{EBO} V _{EB} =(-)4V, I _C =0			(-)0.1	mA
DC Current Gain	h _{FE} (1) V _{CE} =(-)2V, I _C =(-)1A	70*		280*	
	h _{FE} (2) V _{CE} =(-)2V, I _C =(-)5A	30			
Gain-Bandwidth Product	f _T V _{CE} =(-)5V, I _C =(-)1A		10		MHz
C-E Saturation Voltage	V _{CE(sat)} I _C =(-)4A, I _B =(-)0.4A			(-)0.4	V
C-B Breakdown Voltage	V _{(BR)CBO} I _C =(-)1mA, I _E =0	(-)60			V
C-E Breakdown Voltage	V _{(BR)CEO} I _C =(-)1mA, R _{BE} =∞	(-)50			V
E-B Breakdown Voltage	V _{(BR)EBO} I _E =(-)1mA, I _C =0	(-)6			V

Continued on next page.

Package Dimensions 2049B
(unit: mm)

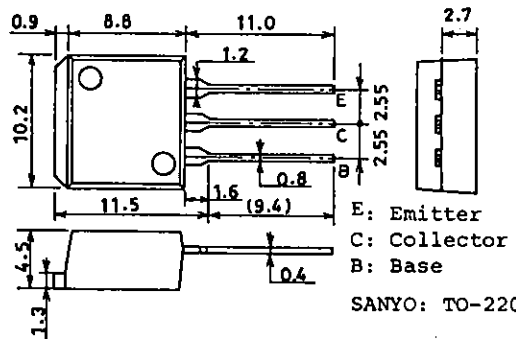

Continued from preceding page.

			min	typ	max	unit
Turn-on Time	t_{on}	See specified Test Circuit.		0.2		μs
Storage Time	t_{stg}	"	(0.1)	0.3		μs
Fall Time	t_f	"	(0.7)	0.9		μs

*: The 2SB1269/2SD1905 are classified by 1A h_{FE} as follows:

70 Q 140	100 R 200	140 S 280
----------	-----------	-----------

Switching Time Test Circuit

(For PNP, the polarity is reversed.)

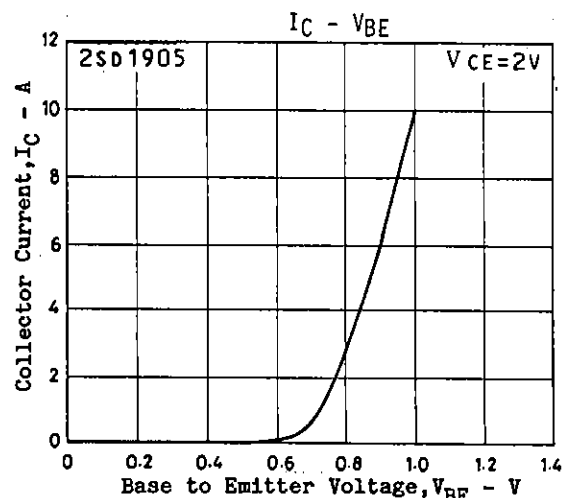
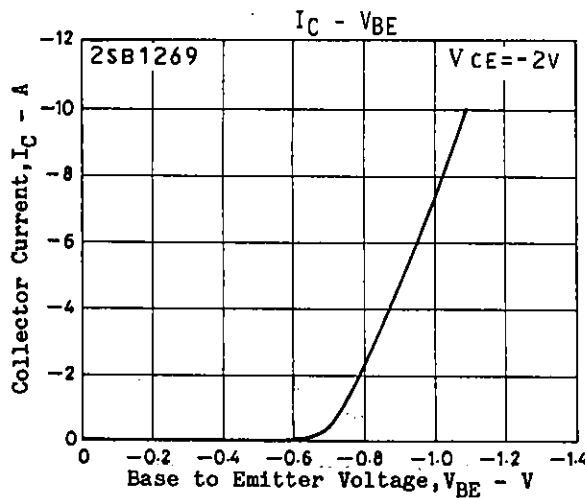
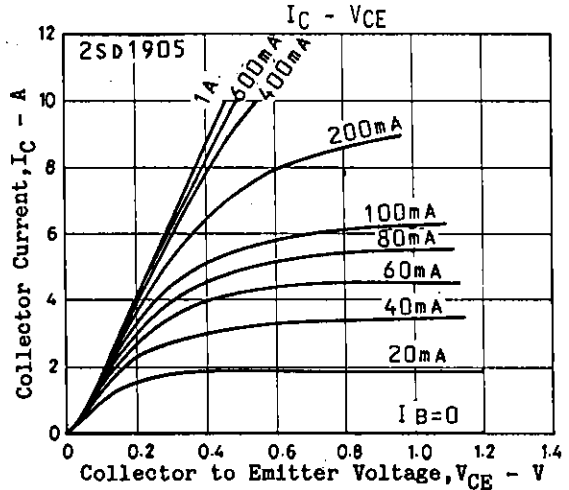
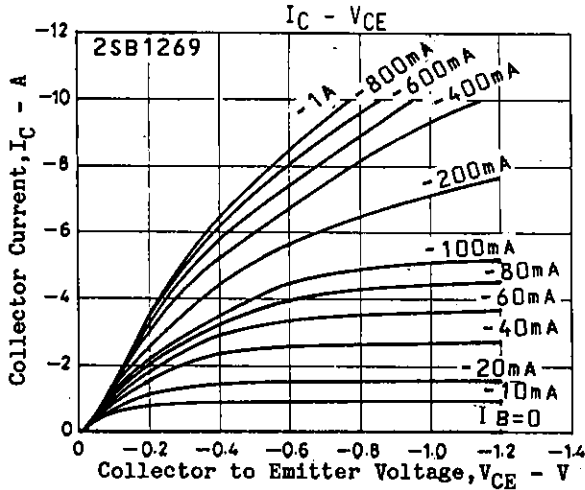
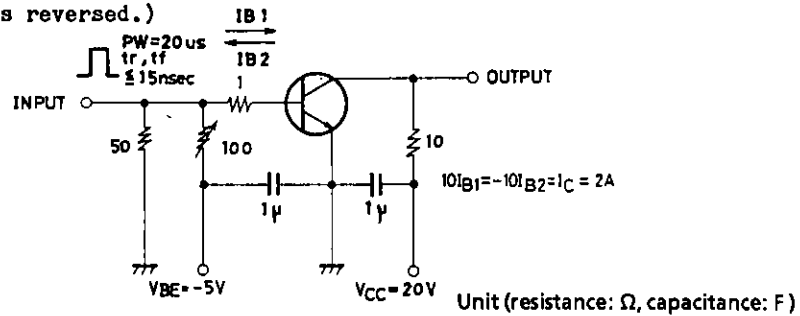

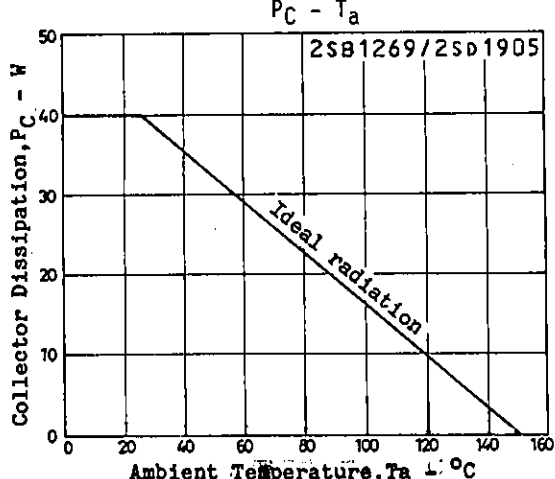
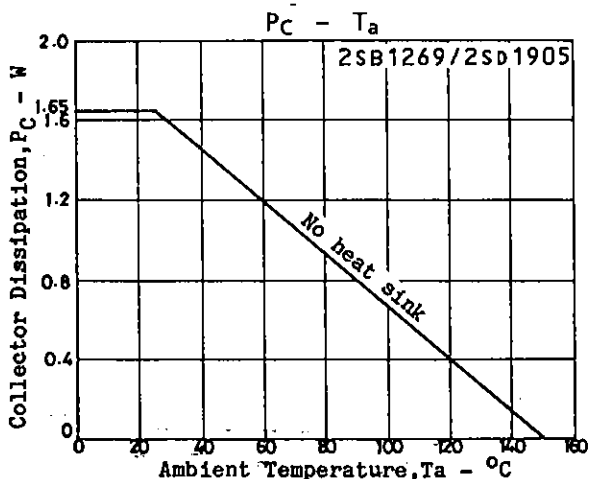
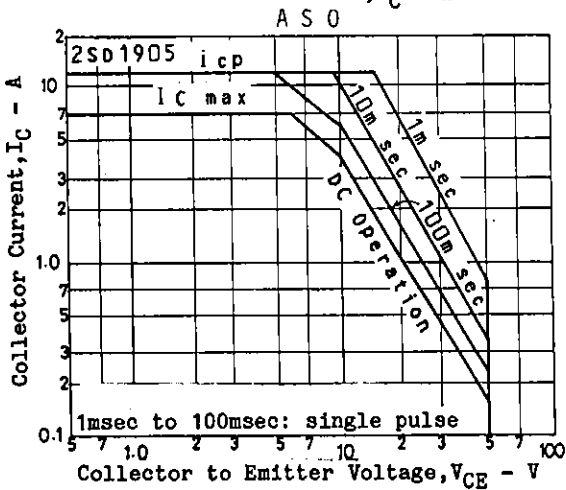
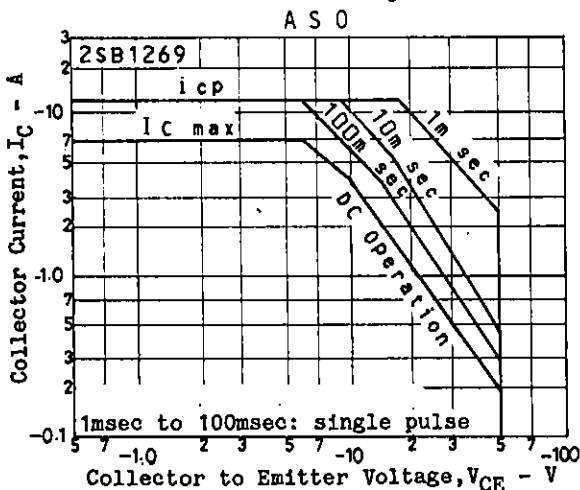
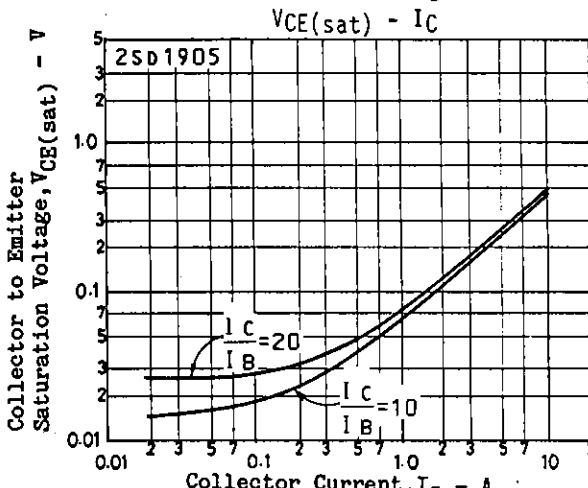
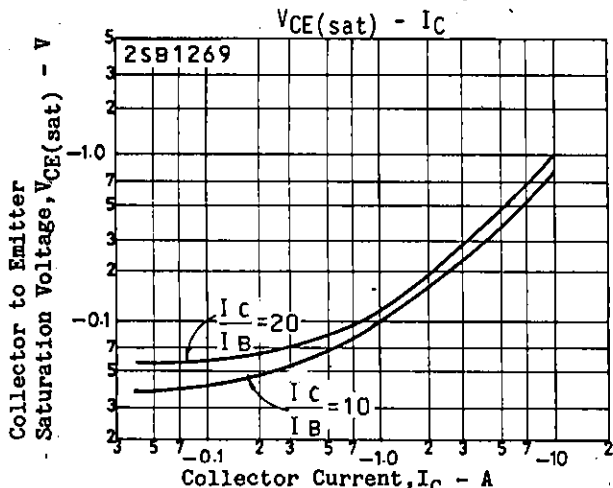
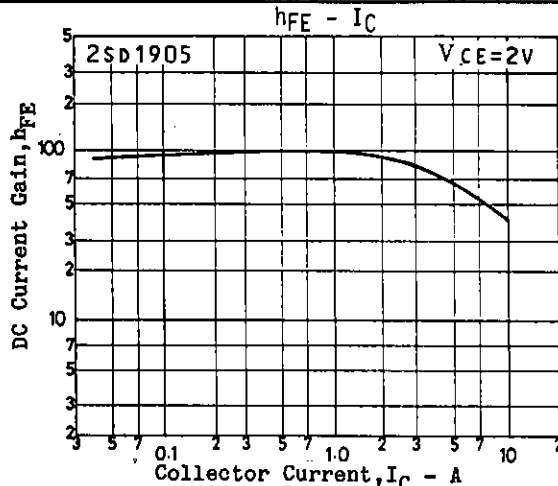
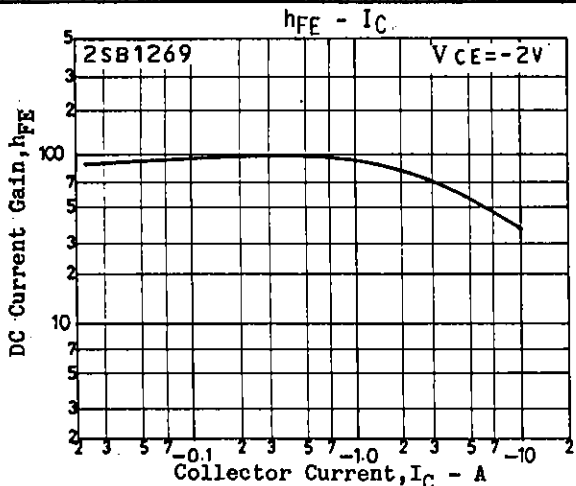

- No products described or contained herein are intended for use in surgical implants, life-support systems, aerospace equipment, nuclear power control systems, vehicles, disaster/crime-prevention equipment and the like, the failure of which may directly or indirectly cause injury, death or property loss.
- Anyone purchasing any products described or contained herein for an above-mentioned use shall:
 - ① Accept full responsibility and indemnify and defend SANYO ELECTRIC CO., LTD., its affiliates, subsidiaries and distributors and all their officers and employees, jointly and severally, against any and all claims and litigation and all damages, cost and expenses associated with such use;
 - ② Not impose any responsibility for any fault or negligence which may be cited in any such claim or litigation on SANYO ELECTRIC CO., LTD., its affiliates, subsidiaries and distributors or any of their officers and employees jointly or severally.
- Information (including circuit diagrams and circuit parameters) herein is for example only; it is not guaranteed for volume production. SANYO believes information herein is accurate and reliable, but no guarantees are made or implied regarding its use or any infringements of intellectual property rights or other rights of third parties.